

BFV DRUM-HEATERS

Heating blankets for drums installation manual



Installation manual

BFV drum-heaters standard range



Index

BFV drum heaters

Security instructions -----	Pgs. 3 to 4
BFV heating blankets schemes -----	Pg. 5
General characteristics -----	Pg. 6
Technical characteristics -----	Pg. 7

Installation / Operating Instructions

BFV drum-heaters | straps and buckles | **AT056** integrated analog thermostat

Installation of the drum-heaters -----	Pgs. 8 to 10
AT056-i Integrated analog thermostat -----	Pg. 11

Installation / Operating Instructions

BFV drum-heaters | velcro | **AT056** analog thermostat

Installation of the drum-heaters -----	Pgs. 12 to 14
AT056 analog thermostat -----	Pg. 15

Installation / Operating Instructions

BFV drum-heater | **DPA** digital programmable thermostat

Installation of the drum-heaters -----	Pgs. 16 to 18
DPA digital programmable thermostat -----	Pg. 19

Maintenance

Operation -----	Pg. 20
Maintenance -----	Pg. 20
Waste management -----	Pg. 20

Troubleshooting Guide

Troubleshooting guide -----	Pg. 21
-----------------------------	--------

Request for custom heating blankets

Request form -----	Pg. 22
--------------------	--------

BFV range

Our other heating blankets -----	Pg. 23
----------------------------------	--------

Security instructions

Important

- Read and make sure you understand this manual before installing the heating blanket.
- Not understanding this manual correctly can cause serious accidents, injuries, and structural damage.

General points

No modifications or alterations can be made to the heating blanket without authorisation from the manufacturer, in the event of this, the guarantee will be invalidated.

National standards and safety regulations must be observed.

Fundamental safety instructions



Anyone involved with the operation, maintenance and repair of the heating jacket should read and be aware of the contents of the instruction manual.

The heating jacket should only be operated by trained personnel.



The mains supply connection has to be in accordance with the corresponding regulations. For safety reasons the equipment must be only operated, if a Residual Current protective Device (RCD) with a release current of 30 mA is connected upstream. This must be checked by a qualified electrician.

According to current regulations, electrical resources must be checked periodically.



Repairs on the electrical components in the heating jackets must be carried out by an electrician or trained personnel under the supervision of an electrician.



The heating jacket should only be used when it is in full working order under the supervision of the operator.



The heating jacket should not be used in damp or wet conditions and should not be exposed to aggressive chemicals. Do not use any other heating appliances in addition to the heating jacket.

Security instructions

Important safety Instructions

The user who has not read or understand all the steps in these instructions is not qualified to use this product.

- Check for suspected damage to the heater like rips, punctures, etc.
- Never immerse the heater into liquids.
- Keep sharp metal objects away from the drum heater.
- Avoid volatile fuels near the heater when it is running.

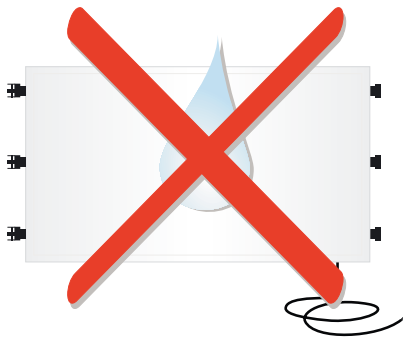

Do not dip into liquids

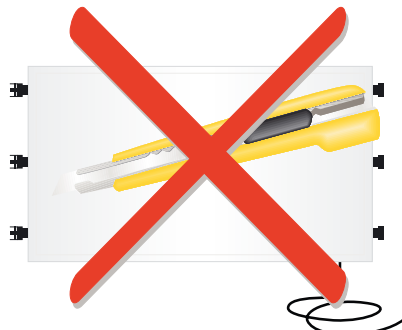

Do not expose to sharps



Avoid volatile fuels

- Do not use the heater with tears or breaks in the surface.
- If the heater is damaged or malfunctions, do not repair the heating blanket, contact the manufacturer.
- Do not crush the heater or subject it to severe stress, neither the power input cable (mains cable).
- When the heater is not in use, unplug from mains.
- Before removing the heater, wait until it is cold.
- Use the heater for its specific purpose, do not use it for other applications..
- Do not overlap the blanket when the drum heater dimensions are larger than the container.

The end user must meet the following requirements

- Only qualified personnel are authorized to handle and connect the electrical wiring.
- All electrical wiring must follow the electrical applicable regulations.
- The final installation and wiring must comply with current regulations.
- The end user is responsible for providing a secure network and, if necessary, give it the necessary mechanisms for maximum safety (thermostats, icp, breaker, etc.).

Heating jacket scheme

Use and intended purpose

The **BFV** heating blankets are designed for controlling and maintaining the temperature of drums (plastic or metal) from 25 to 200 liters.

- Viscosity control
- Freeze protection
- Temperature maintenance
- Solids fusion
- Heating to a required temperature
- Thermal mix

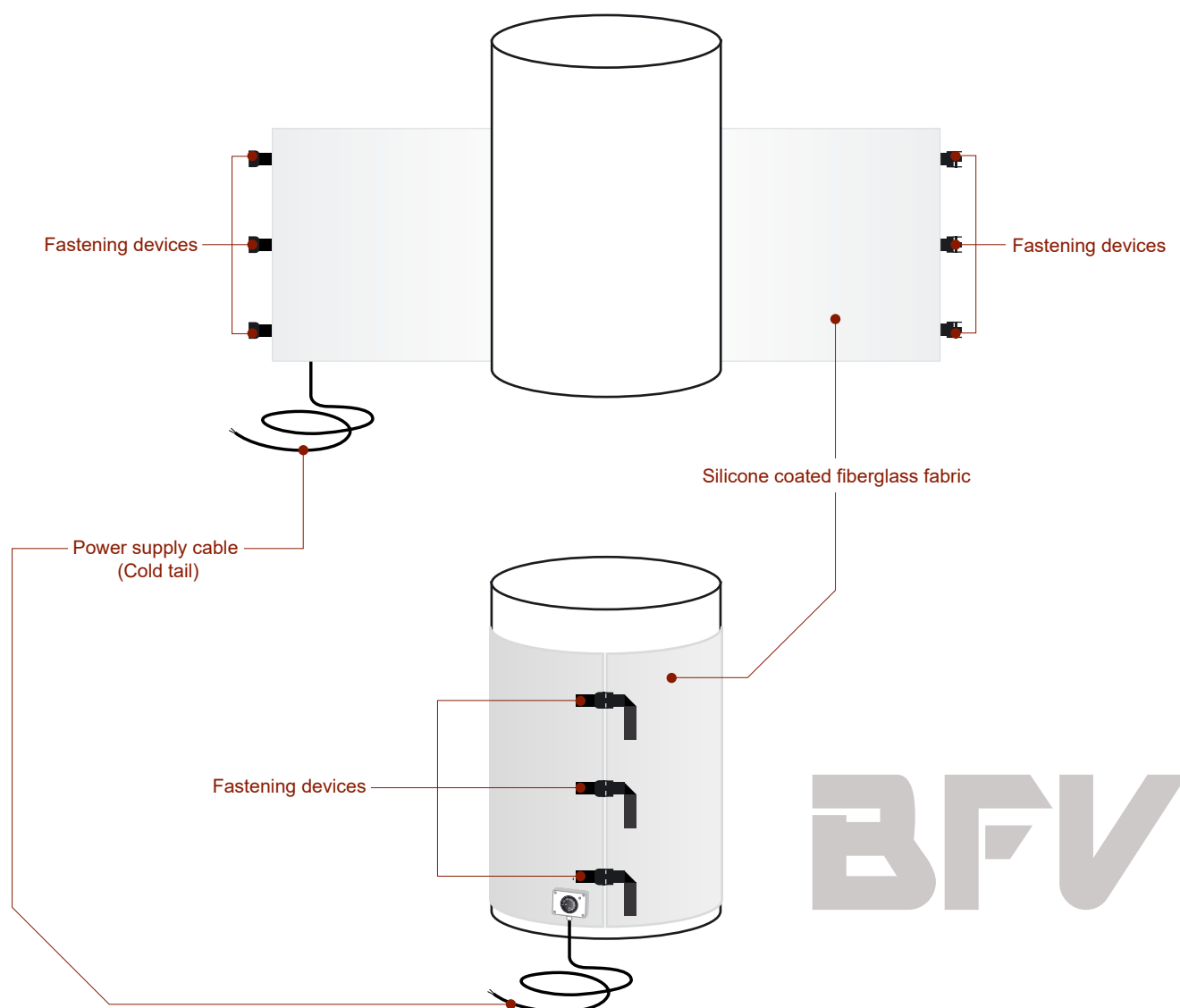

General characteristics

• **Fabric**

Silicone coated fiberglass



• **Fastening device**

Nylon straps with plastic buckles

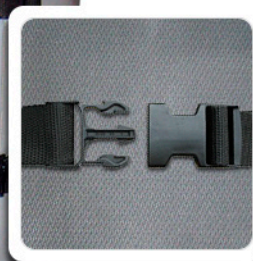

• **Label**

Technical characteristics and CE marking



• **AT056**

Analog thermostat 0-90° C included as standard



• **Power cable**

Connecting cable to mains



BFV

Technical characteristics

Range	BFV
Application areas:	Temperature control and heating for drums
Power delivery at 230 V - 50 Hz:	Depending on model. See label or technical data sheet of the heating blanket
Maximum working temperature:	90° C ± 5° C
Minimum working temperature:	- 40° C ± 5° C
Heating conductor:	Ni/Cr 80/20
Conductor insulation:	Thermal silicone double insulation
Maximum working temp. of the conductor:	- 40 / 180° C
Heating blanket insulation:	Siliconed fiberglass fabric
	100% Textured filament fiberglass
	Treatment: One side silicone translucent
	Weft: EC-9-136 Tex * 1
	Warp: EC-9-136 Tex * 1
	Tensile strength
	Weft: 5000N/5 cm
	Warp: 3000N/5 cm
	Total thickness of the heating blanket: 14 mm
	Fabric: Cross Twill
	Fire resistance: IMO Res. MSC.61(67) FTP - Cod
Approximate dimensions:	Depending on model. See label or technical data sheet of the heating blanket
Type of fastener device:	Depending on model. See label or technical data sheet of the heating blanket
Dielectric strength:	1.500 V 1 min. ≥ 50GΩ
Power cable:	Depending on model. See label or technical data sheet of the heating blanket
Standards:	2014 / 35 / UE
	2014 / 30 / UE
	EN60335-1
	EN ISO 12100-1 & 2
Safety thermostat:	Internal micro-thermostat 91° C (+5° C - 15K)
Thermostat:	AT056: -10 / 90° C ±4° C 16A 230 V - 50 Hz Acerinox bulb and capillary sensing



BFV drum-heater | Straps and buckles | AT056 integrated thermostat

Installation / operating instructions:

Installation instructions for the heating blankets of the **BFV** range, with integrated analog adjustable thermostat **AT056**.

It is important to read and understand this manual thoroughly before operating the drum heater.

These instructions are for the following standard models, as well as blankets that incorporate the integrated **AT056** thermostat:

25-30 L drums	50-60 L drums	100 L drums	200 L drums
BFV1020400250	BFV1250450275	BFV1650350575	BFV17704501000
BFV1020400450	BFV1250450625	BFV1650350750	BFV19504501000
			BFV1950850900
			BFV19508501500
			BFV19508502300
			BFV17709001500

Step 1

- 1.1. Get the drum-heater out of the box. Be careful not to damage the **AT056** thermostat.
- 1.2. Make a visual inspection of the heating blanket. Do not use the heater if it shows a torn or damaged.
- 1.3. The inspection and installation is preferably done by two people.

Step 2

- 2.1. Place the heater on a clean and dry surface.

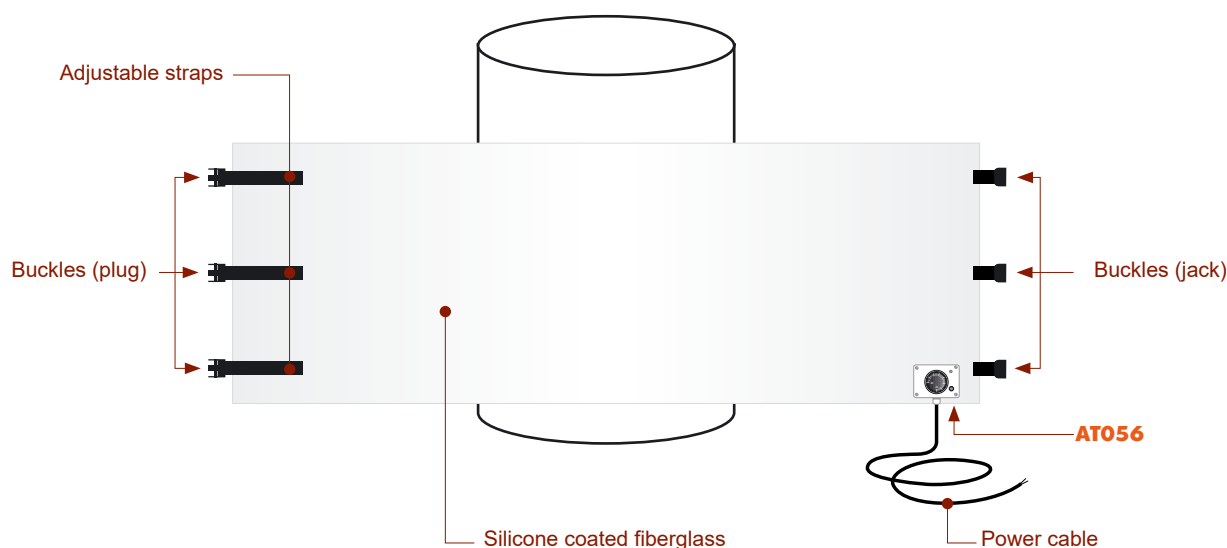

Installation of the drum-heaters

2.2. Determine the best place to put the blanket: It is recommended to put on the bottom of the drum or container.

The thermostat and the supply cable of the heating blanket should be at the bottom.

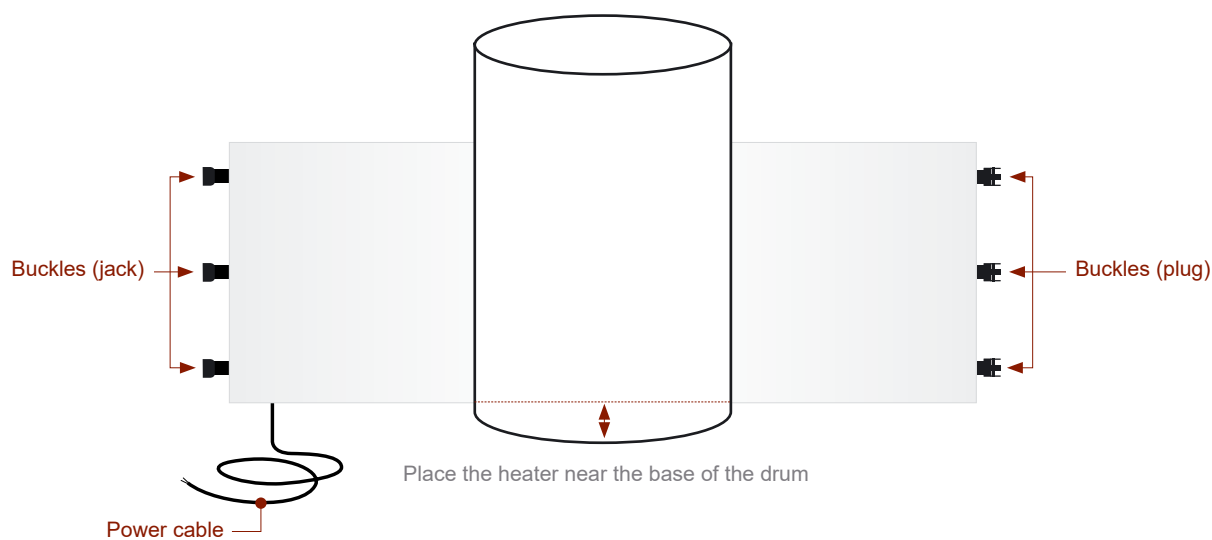

2.3. Set the heater around the body of the drum, tightly hugging the blanket with the straps and buckles.

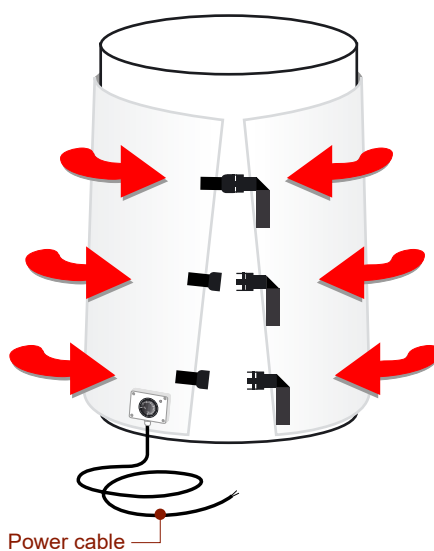

Installation of the drum-heaters

2.5. Firmly tighten the blanket to the body of the drum, pulling the straps until the proper tension is achieved.

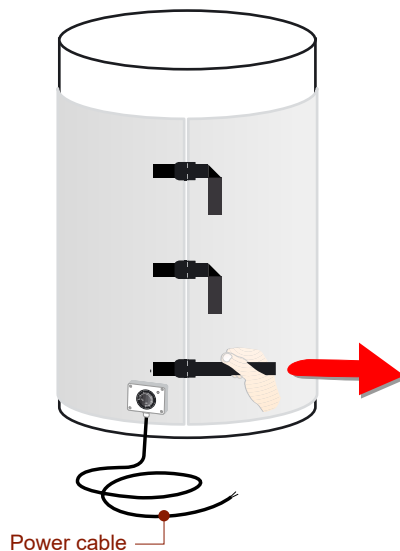

- To get the best performance from the heating blanket, it must be tightly fitted to the body of the drum

Step 3

3.1. Connect the power cable to the mains..

The electrical installation where the heater will be connected, must be properly evaluated, and take into account power and tension of the blanket, to avoid failures or errors.

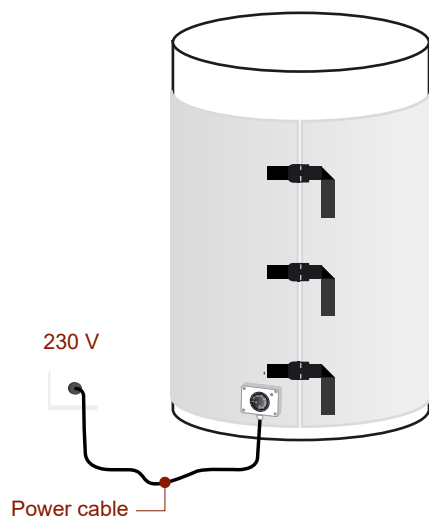

Thermostat

AT056-i

Thermostat incorporated as standard with our heating blankets:

AT056



Integrated economic analog thermostat:

- Analog thermostat
- Temperature range: 0-90° C
- Voltage: 230 V - 50 HZ
- Amperage: 3, 5, 7, 10, 12, 16 A (depending on model)
- On/Off differential: 4° C
- Sensor built into the heating blanket

For heating blankets incorporating the adjustable analog thermostat **AT056**: Set the thermostat knob to the desired working temperature. The thermostat can be adjusted from 0 to 90° C.

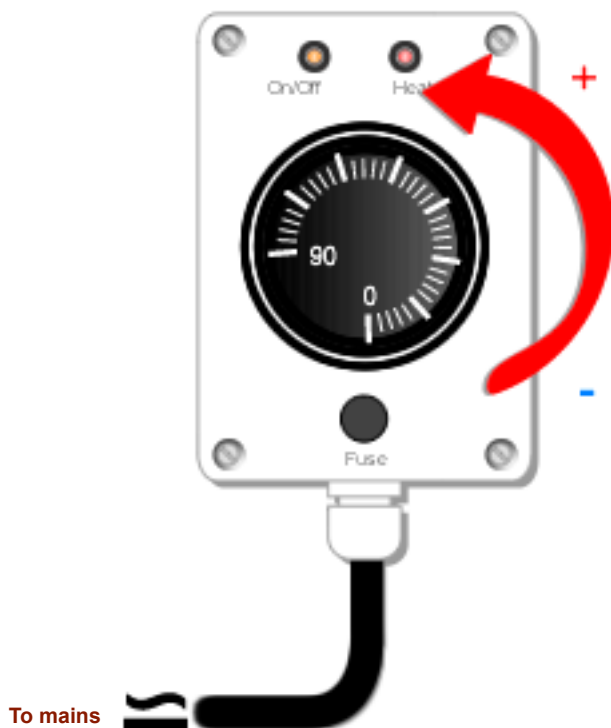

AT056-i
INTEGRATED



• **Attention:** Removing the seal invalidates the warranty.

BFV drum-heater | velcro | AT056 analog thermostat

Installation / operating instructions:

Installation instructions for the heating blankets of the **BFV** range, with analog adjustable thermostat **AT056**.

It is important to read and understand this manual thoroughly before operating the drum heater.

These instructions are for the following standard drum-heaters, as well as the blankets that incorporate the thermostat **AT056**:

Bidones de 25-30 L	Bidones de 50-60 L	Bidones de 100 L	Bidones de 200 L
BFV845150200	BFV1005150300	BFV1385150750	BFV1770150750
	BFV1250150350		

Step 1

- 1.1. Get the drum-heater out of the box.
- 1.2. Make a visual inspection of the heating blanket. Do not use the heater if it shows a torn or damaged.
- 1.3. The inspection and installation is preferably done by two people.

Step 2

- 2.1. Place the heater on a clean and dry surface.

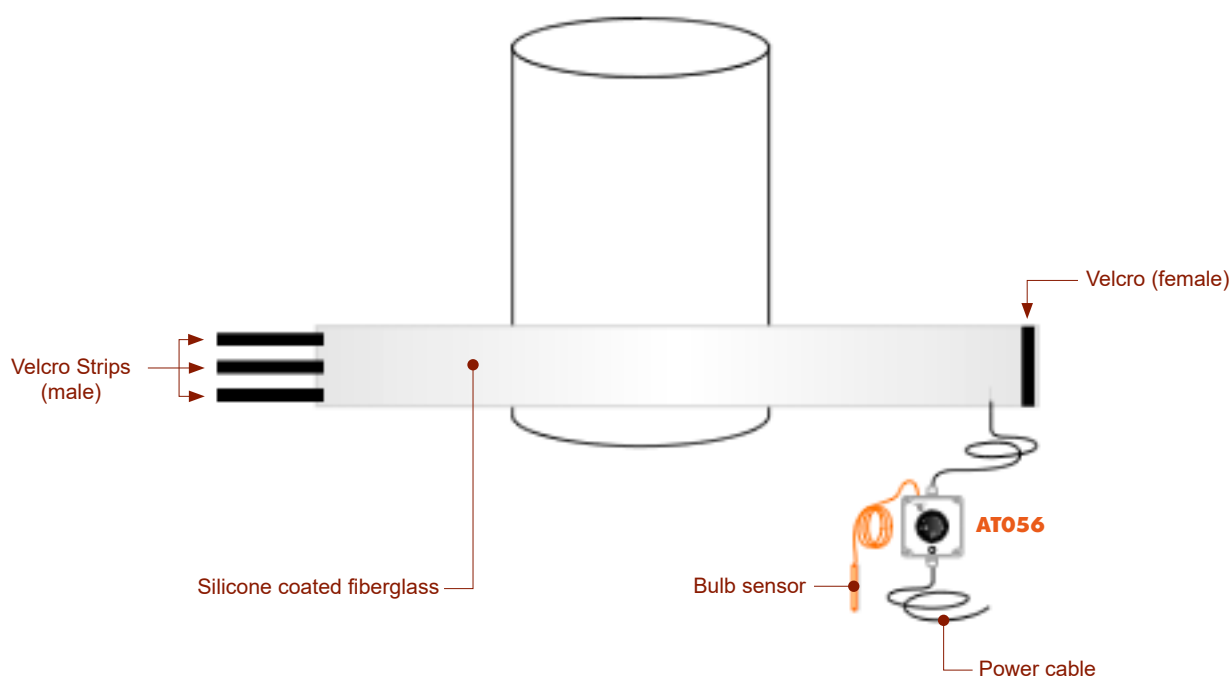

Installation of the drum-heaters

2.2. Determine the best place to put the blanket: It is recommended to put on the bottom of the drum or container.

The thermostat and the supply cable of the heating blanket should be at the bottom.

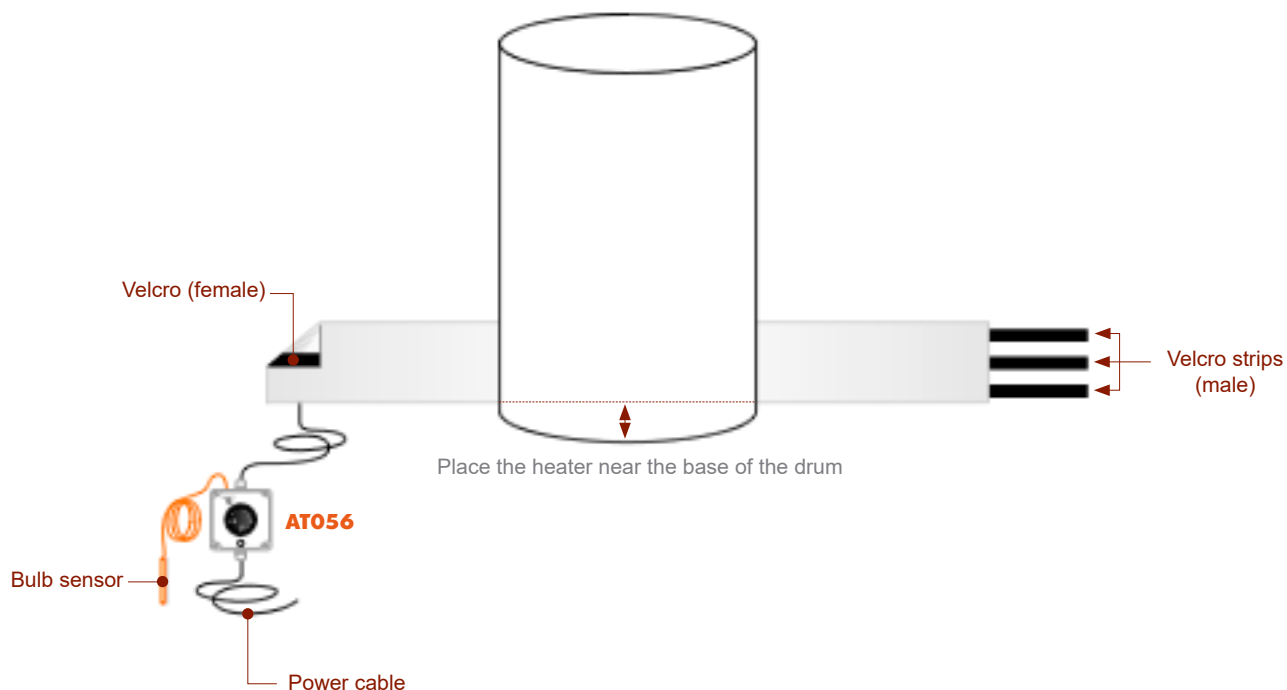

2.3. Set the heater around the body of the drum, tightly hugging the blanket with the velcro strips to get the proper tension.

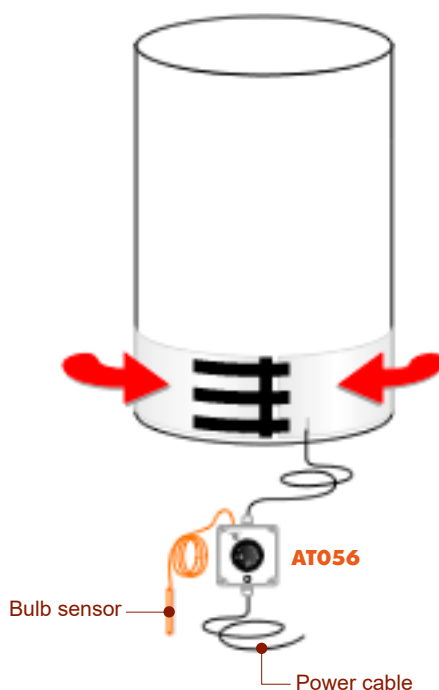

Installation of the drum-heaters

2.4. Place the bulb, carefully, between the heater and the surface of the drum.

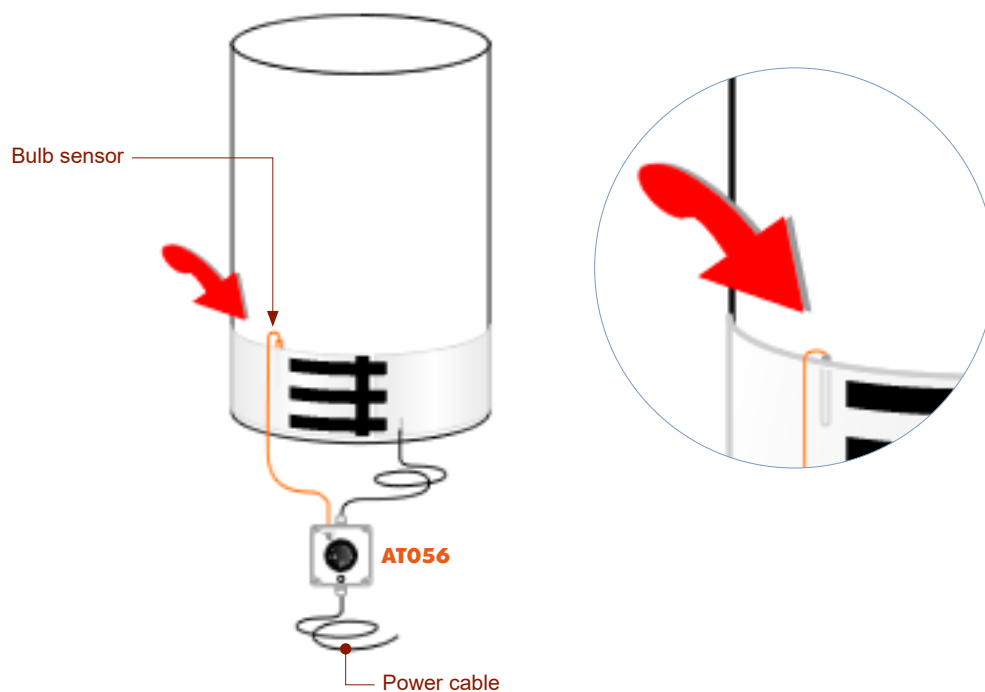

Step 3

3.1. Connect the power cable to the mains.

The electrical installation where the heater will be connected, must be properly evaluated, and take into account power and tension of the blanket, to avoid failures or errors.

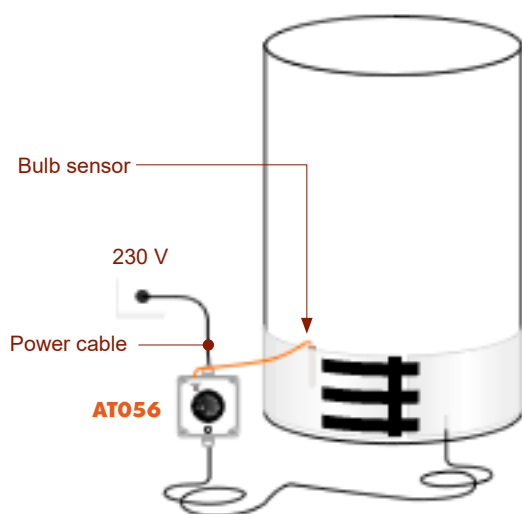

• To get the best performance from the heating blanket, it must be tightly fitted to the body of the drum

Thermostat

AT056

Thermostat incorporated as standard with our heating blankets:



Economic analog thermostat:

- Temperature range: 0-90° C
- Voltage: 230 V - 50 Hz
- Amperage: 3, 5, 7, 10, 12, 16 A (depending on model)
- On/Off differential: 4° C
- Sensor: Bulb and capillary sensing - 1 metre

For heating blankets incorporating the adjustable analog thermostat **AT056**: Set the thermostat knob to the desired working temperature. The thermostat can be adjusted from 0 to 90° C.

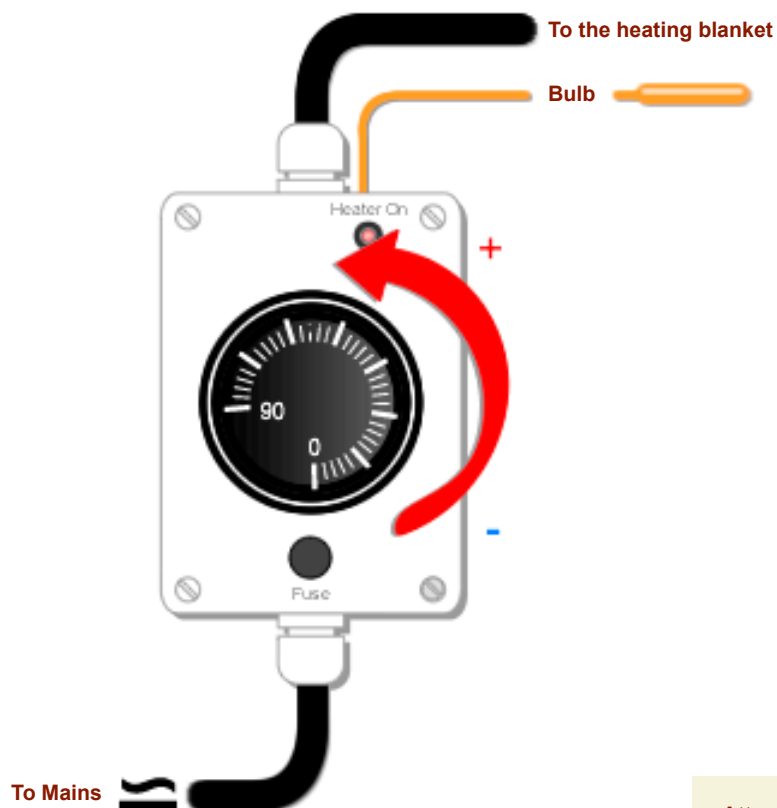

AT056



• **Attention:** Removing the seal invalidates the warranty.

BFV drum-heater | DPA programmable thermostat

Instalación / instrucciones de operación:

Installation instructions for the heating blankets of the **BFV** range, with programmable digital control device **DPA**.

It is important to read and understand this manual thoroughly before operating the drum heater.

These instructions are for any type of heating blanket that includes a programmable thermostat of the **DPA** range

Step 1

- 1.1. Get the drum-heater out of the box.
- 1.2. Make a visual inspection of the heating blanket. Do not use the heater if it shows a torn or damaged.
- 1.3. The inspection and installation is preferably done by two people.

Step 2

- 2.1. Place the heater on a clean and dry surface.

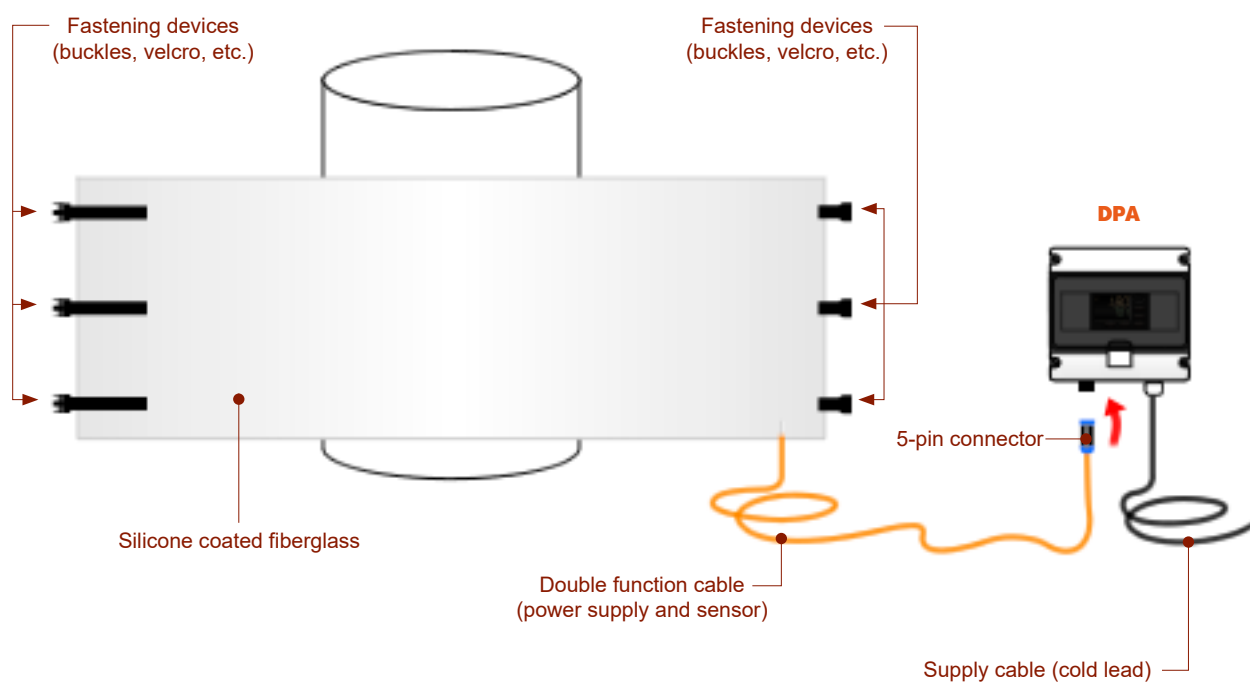

Installation of the drum-heaters

2.2. Determine the best place to put the blanket: It is recommended to put on the bottom of the drum or container.

The thermostat and the supply cable of the heating blanket should be at the bottom.

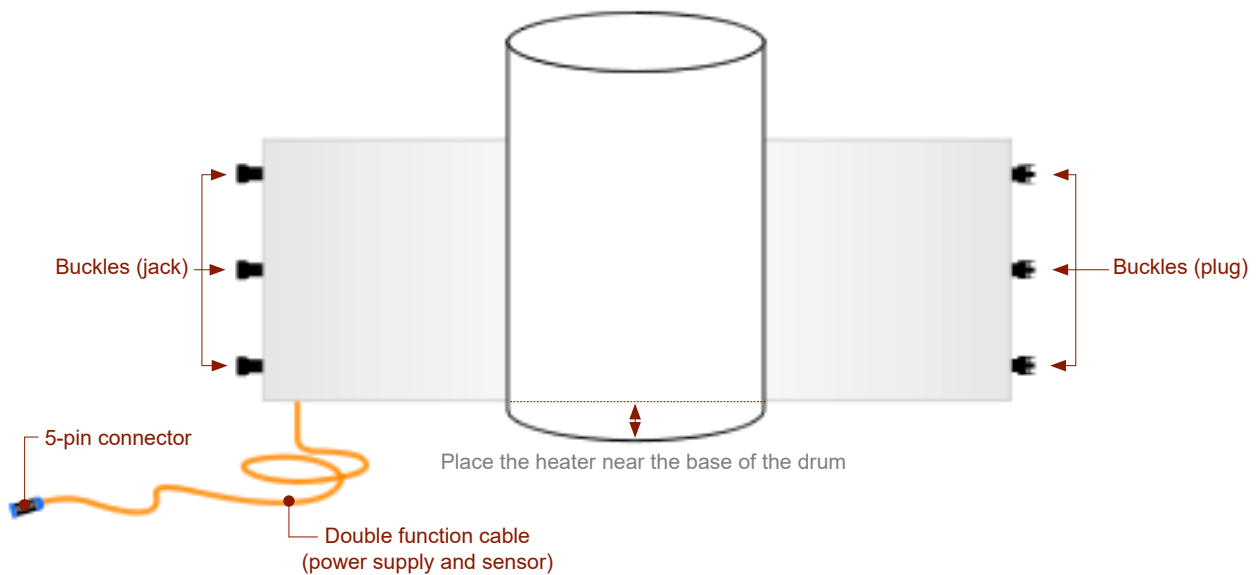

2.3. Place the heater around the body of the drum, tightly hugging the blanket with the fastening device: straps and plastic buckles, velcro, springs, etc.

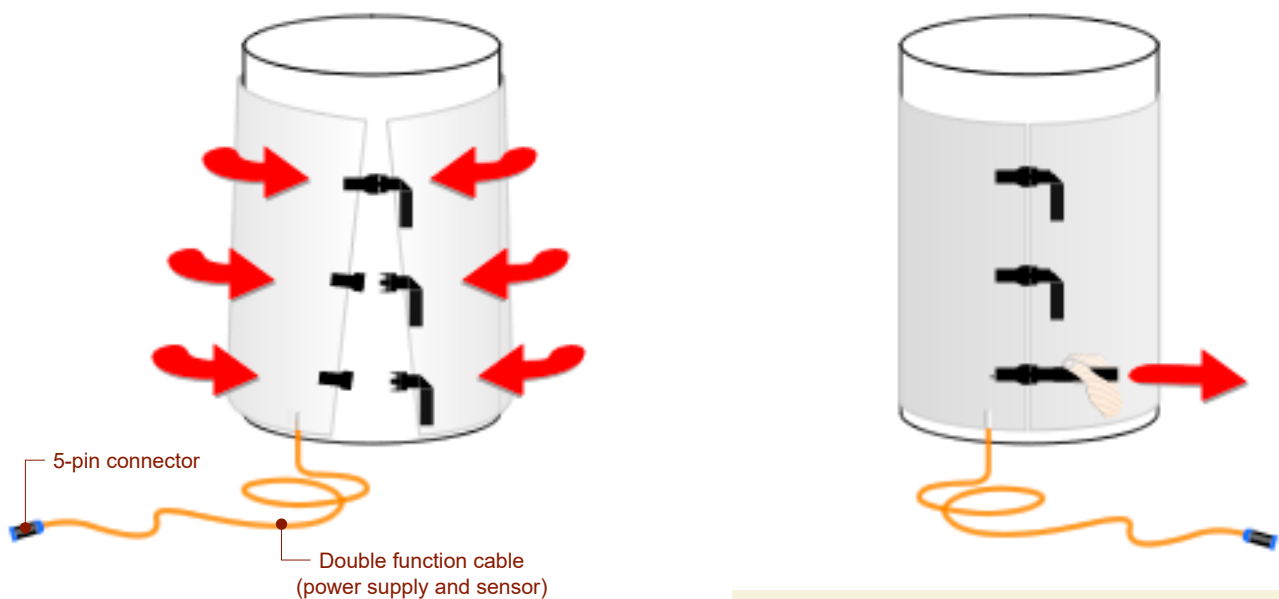

• To get the best performance from the heating blanket, it must be tightly fitted to the body of the drum

Installation of the drum-heaters

2.4. Connect the heating blanket to the **DPA** digital thermostat with the double function cable at the end of which there is a 5-pin male connector which we will plug to the female connector on the **DPA** digital thermostat.

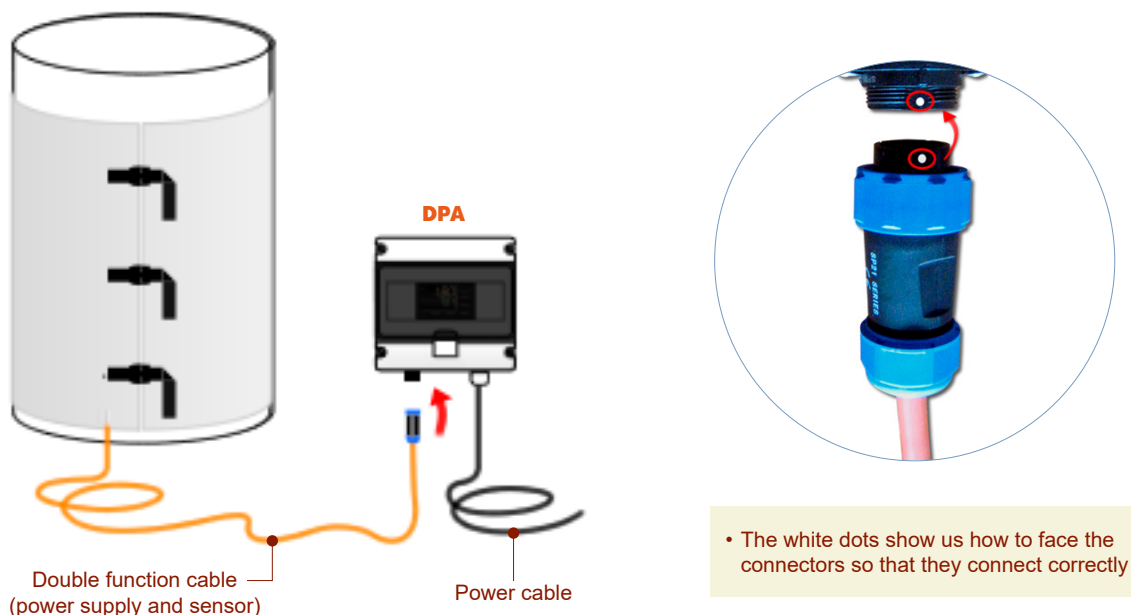

2.5. Once the heating blanket is connected to the **DPA** thermostat, connect the thermostat to the mains.

The electrical installation must be adequately carefully evaluated, and take into account power and tension of the blanket, to avoid failures or errors.

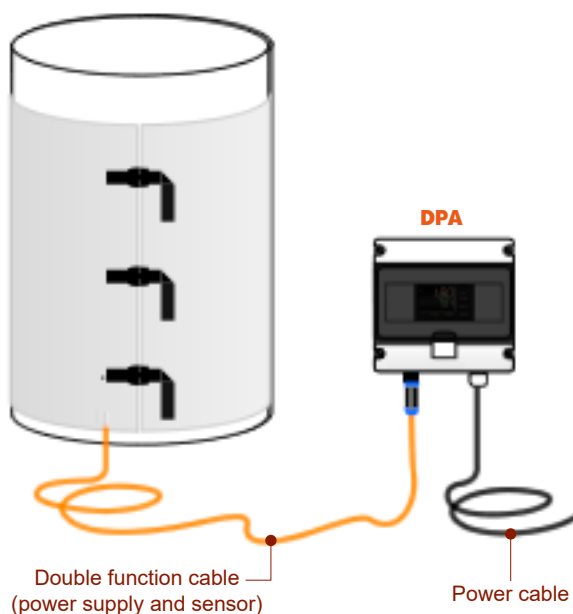

Thermostat

DPA

Programmable digital thermostat incorporated to our heating blankets on demand:

DPA



Programmable digital thermostat

- Control panels prepared to work outdoor, from -20° C to +140° C
- Case with transparent window: IP-65
- Connection entrances: PG-9
- Relay output: 25 A
- Allows different types of sensors: PTC, PT100, etc.
- Voltage: 230 V - 50 Hz

If your heating blanket incorporates a programmable digital thermostat of the **DPA** range, you must follow the instructions in the attached manual.

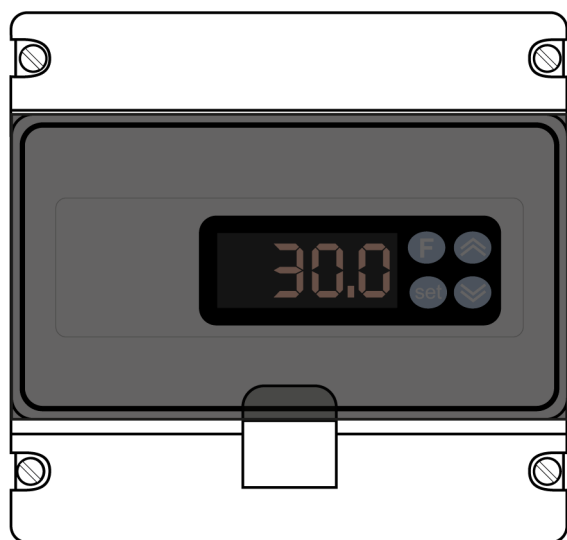

Heating blanket cable 5-pin connector
(Power supply and sensor)

Power cord

DPA



• **Attention:** Removing the seal invalidates the warranty.

Operation and maintenance

Operation

It is very important that when we use the heating blanket to heat the drum and its contents, safety is guaranteed.

1. Check the electrical cable and the distribution box before using the heating blanket. Let's check that they do not present any damage.
2. Wrap the drum that we want to heat with the heating blanket.
3. Tight the heating blanket with the straps so that it adapts well to the container, firm, but without being extremely tight.
4. Make sure that the container is always open, to avoid pressure build-up from heating.
5. The heating blanket has an adjustable thermostat. We will turn the knob until we get the desired value. The temperature It is not the inner temperature, but the temperature of the walls of the container.
6. Connect the heating blanket only when it is properly placed, the top of the container is open and the temperature is regulated.
7. Monitor the heating process. We will not let the heating blanket work without the supervision of a qualified operator.
8. ATTENTION! During heating, superheated vapors may be released.
9. ATTENTION! During heating, hot surfaces will emerge.
10. When we finish using the heating blanket, we will first unplug it from the power supply and let it cool down to not suffer burns.
11. Let the blanket cool by spreading it carefully on a flat surface. We will not leave it rolled up or folded.
12. Once cold, we will keep it in a place where it is not exposed to moisture, sharp objects, etc.

Maintenance and conservation

Before cleaning the heating blanket, we will unplug it from the power supply.

We will pass a damp cloth on the surface of the blanket.

We will not use solvents or bleach and we will never immerse it in any type of liquid.

Waste management

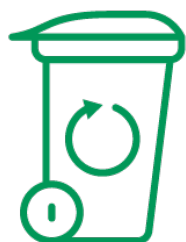

Following the Electrical and Electronic Equipment Act, owners of old equipment are required by law to take old electrical and electronic equipment to a waste collection point.

Help protect the environment; do not throw your old equipment in the household trash.

Troubleshooting

Contact details

Please, read this manual before you contact **Elementos Calefactores AS**, or your local distributor.

This guide is designed to answer frequently asked questions. If you can not identify the problem or need additional assistance, please contact **Elementos Calefactores AS** through the following data:

- Telf. 00 34 93 486 36 82
- Fax: 00 34 93 486 38 14
- E-mail: as@elementoscalefactores.com

Troubleshooting solutions guide

The tank heater does not heat:

1. Make sure the blanket is connected to the correct voltage supply. You will find technical specifications of the tank heater at the label attached to the cord or at the product data sheet.
2. Unplug the heating blanket:
 - For blankets with the analog thermostat **AT056**, turn the radio button at 0 °C, re-connect it and re-select the desired temperature work.
 - For blankets with the **DPA** digital thermostat or similar, turn-off the thermostat, turn it on again, and check the set temperature SET POINT.
3. Check that the tank heater is connected to a magneto-thermic switch with enough amperage.
4. Verify the power supply cable of the heating blanket, is not damaged.

Important

The **BFV** range of heating blankets for drums are designed for a specific use. Giving them another use can affect its effectiveness, cause structural damage, and even cause serious accidents to the personnel who handle the blankets.

The improper use or manipulation of the heating blanket, as well as its components and accessories, may invalidate the warranty.



Heating blankets request

Request form

If you don't find a heater that fulfills your needs, please feel free to suggest any modification as measures, power output, voltage, etc.:

- Email: as@elementoscalefactores.com
- Fax: 00 34 93 486 38 14

Contact data

Name | Last name: Company:.....
 Telephone:..... Email:.....
 Address:..... PC:
 City: Country:

Project details

Location (city):.....
 Inner, outer, both:

Characteristics of the container

Height (mm):
 Perimeter (mm):
 Estimated power:
 Constitution of the drum or tank (metal, plastic, etc.):.....
 Units needed:

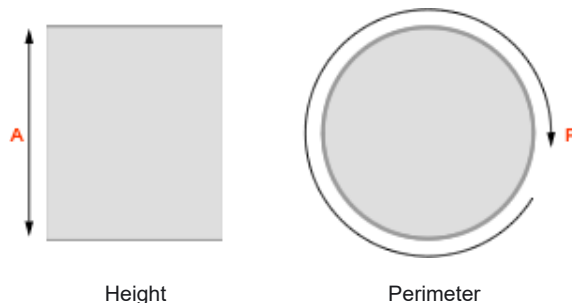

Height

Perimeter

Product features

Kind of product:
 Room temperature:
 Temperature to achieve:

Type of fastener

Velcro:
 Nylon straps with plastic buckles:
 Springs:
 Other (specify):.....



Temperature and control device

AT056: Analogue thermostat -10/90° C.....
 DP16A: Digital programmable thermostat -20 a +140 ° C
 Other: Specify:.....

Our other heating blankets



BFV-IBC: Heating blankets for IBC tanks of 1.000 L.
Learn more: <https://www.elementoscalefactores.com/aplicaciones-en/ibc-tank-heaters.htm>



BFV-EM: Heating bands for electric motors.
Learn more: <https://www.elementoscalefactores.com/aplicaciones-es/calentadores-motores.htm>



BFV-AT: Heating blankets for High Voltage cables.
Learn more: <https://www.elementoscalefactores.com/aplicaciones-en/heating-blanket-HV-cables.htm>



BFV-CC: Heating blankets for curing.
Learn more: <https://www.elementoscalefactores.com/aplicaciones-en/heating-blankets-curing.htm>

ELEMENTOS CALEFACTORES AS, S.L

C/ Zamora, 99 - 101, 5º planta 1ª
08018 Barcelona
Tel. 00 34 93 486 36 82 - Fax 00 34 93 486 38 14
Email: as@elementoscalefactores.com



ECAS GROUP

- **Main website** •

www.elementoscalefactores.com

- **Online store** •

www.electriceatingstore.com

